

American Beauty

Quality Soldering Tools Since 1894

*Soldering
Solutions*



Continuing a Tradition of Excellence

A True American Beauty®

In the early 1900s a customer was so impressed with the durability and reliability of his newly purchased soldering iron he declared it "a true American Beauty®." More than a century later, these qualities define the unwavering tradition of excellence that motivates American Beauty® to deliver durable, robust soldering solutions.

Our professional tools are reminiscent of a time when people took pride in the tools they used—and companies took pride in the tools they manufactured.

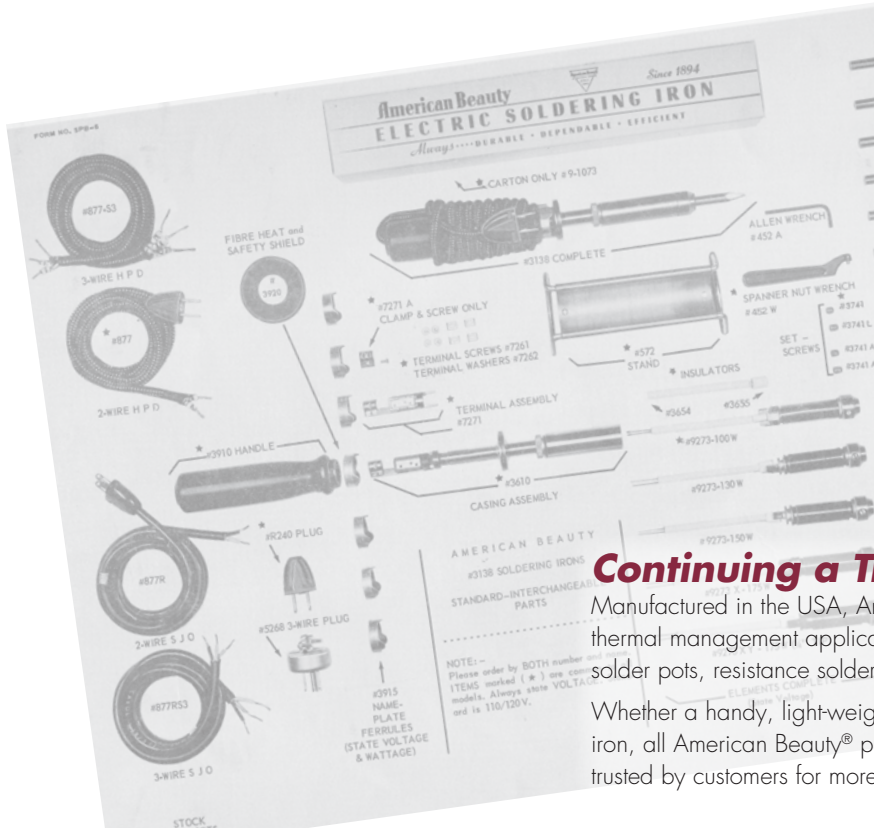

Continuing a Tradition of Excellence

Manufactured in the USA, American Beauty® solves challenging soldering and thermal management applications with a diverse line of soldering irons and stations, solder pots, resistance soldering systems and accessories.

Whether a handy, light-weight 20 watt pencil iron or a 550 watt robust heavy-duty iron, all American Beauty® products are produced to the high-quality standards trusted by customers for more than a century.



Continuing a Tradition of Excellence

Performance

American Beauty® provides high-performance solutions for every soldering application. Generating intense, consistent heat far beyond that of average soldering tools, our heavy-duty soldering irons withstand aggressive production-line environments, soldering systems provide intense localized heat to overcome heat sinks and lead-free solder pots will maintain consistent high temperature anywhere on your shop floor.

Quality

American Beauty® combines a long tradition of manufacturing excellence with the desire to produce tools that will stand the test of time. Continual investment in new technology, facility upgrades and employee training produces robust soldering tools that we proudly back with the best warranty policy in the industry. A trained quality inspector examines each tool before it leaves the factory and all manufacturing associates are cross-trained on the proper assembly of every American Beauty® product. Our dedicated family of employees maintain integrity through every stage of production ensuring our soldering tools will remain true American Beauties for years to come.

Support

To the customer service staff at American Beauty®, support is not limited to providing accurate and timely information about our tools. We view our role as a solution provider for difficult soldering needs; helping our customers to better understand their soldering applications and working together to improve their overall soldering capabilities.

In our fully equipped testing lab, our soldering technicians replicate our customers soldering bottlenecks and provide real-time feedback. Our free in-house test and evaluation service allows American Beauty® to accurately assess which processes might be modified and which tools will save our customers valuable time and money. Our repair and refurbishment service allows customers to extend the life of their tools, greatly reducing their total cost of ownership.



Soldering Irons

Heavy-Duty Soldering Irons



Features & Benefits

Ni-Chrome Compression Wound Heating Element

Proven to be the most reliable heating element for maintaining soldering temperature in production environments.

Paragon® Iron-Clad Lead-Free Tips

Consistently outperform and outlast ordinary tips.

Iron Uses Plug-Type Tips

Superior heat transfer. Easy maintenance.

Hardwood Handles

Provide superior thermal and electrical insulating properties and durability.

Modular Construction

Easy part replacement.

Designed and Built for Ultimate Performance and Reliability

American Beauty® heavy-duty irons are ideal for heavy soldering jobs and production-line environments. Created by compression winding a special Ni-Chrome heating alloy onto a steel spool, all elements demonstrate an unsurpassed heat capacity and outstanding durability. Protective casings cut from a single block of steel are strengthened with multiple heat treatments and precision-brazed for optimal strength and efficiency.

Check out our Repair & Refurbishment Service (see back cover).

MODEL	WATTAGE	MAXIMUM TIP TEMPERATURE	OVERALL LENGTH	TIP STYLE	TIP SHANK DIAMETER	PRODUCT WEIGHT	REPLACEMENT ELEMENT
3198 (46C)	550	1010°F (543°C)	15.0" (38.1cm)	Chisel	1-1/8" (28.6mm)	5 lbs. (2.26kg)	9279
Designed to tackle the heaviest electrical, industrial and sheet metal soldering jobs, this is by far the soldering iron with the most heat capacity in the American Beauty® product family. Specific applications of interest include 0000 AVVG battery cable terminations in jumbo jets, twelve foot sections of 1/2" overlapped copper flashing, flameless testing of fire detectors at gas stations and heat-sealing on PTFE flexible stadium roofing and poly-vinyl cut-outs.							
3178 (45C)	300	1000°F (538°C)	14.375" (36.5cm)	Chisel	7/8" (22.2mm)	3 1/2 lbs. (1.59kg)	9277
A true workhorse with the necessary thermal capacity and recovery to handle heavy electrical and sheet metal work. Specific applications of interest include downspouts and overlaps on 1/2 round copper gutters, HVAC connections, hermetic sealing of sheet metal in the production of metal burial caskets and sweat soldering thin-walled copper pipe.							
3158X (44D)	250	1000°F (538°C)	14.0" (35.6cm)	Diamond	5/8" (15.9mm)	2 1/4 lbs. (1.02kg)	9275X
3158 (44D)	200	1000°F (538°C)	14.0" (35.6cm)	Diamond	5/8" (15.9mm)	2 1/4 lbs. (1.02kg)	9275
Great for heavy electrical work and intermediate sheet metal. Specific applications of interest include restoration of world's largest Louis Comfort Tiffany stained glass dome, RF connectors to coaxial cable and terminations of magnet wire in electric motors.							
3138X (43D)	175	1025°F (552°C)	13.0" (33.0cm)	Diamond	3/8" (9.5mm)	1 3/4 lbs. (.79kg)	9273X
3138 (43D)	150	1010°F (543°C)	13.0" (33.0cm)	Diamond	3/8" (9.5mm)	1 3/4 lbs. (.79kg)	9273
	130	955°F (513°C)					
	100	855°F (457°C)					
Our most versatile heavy-duty iron with a wide range of wattages easily matched to your specific requirements. A common choice for maintenance, repair and operations (MRO) and for other intermediate electrical work. Specific applications of interest include artisan's sculptures made from various metals and wire terminations common in telecommunication (up to 10AWG).							
3125 (67D)	75	930°F (499°C)	12-1/4" (31.1cm)	Diamond	1/4" (6.4mm)	1 lb. (.45kg)	9271
	60	850°F (454°C)					
Perfect for light electrical and sheet metal work and heavy electronic work. Specific applications of interest include producing amplifiers for the music industry and finishing work on refrigerator doors.							
3114 (67D)	75	1000°F (538°C)	9.0" (22.9cm)	Diamond	1/4" (6.4mm)	3/4 lb. (.34kg)	9270
	60	945°F (507°C)					
Similar to Model 3125, the compact size makes it popular for repair work on the go. Specific applications of interest include repair work and set-up and tear down of large stage shows and concerts.							

*Shipping Weight Formula:

For 1 - 4 irons, add 1/2 lbs. to the total product weight and round up to next whole number.

For 5 - 10 irons, add 1 1/2 lbs. to the total product weight and round up to next whole number.

**Wattage Selection: Some models are available in multiple wattages. Higher wattages equate with faster thermal recovery. While appropriate for overcoming heat sinks or in production environments, higher wattages may experience early element failure if heat is not drawn out of the iron frequently enough.

***220-240 VAC versions and international cord sets are available upon request. Additional charges will apply.

Paragon® Lead-Free Soldering Iron Tips

Starting with a pure copper core, our soldering iron tips undergo multiple processes to ensure the best performance and longest life. The following chart highlights our most popular styles of tips for each of the irons listed above. American Beauty® also carries many other shapes and style of tips, all of which can be found on our website at www.americanbeautytools.com/tips.

46 Series Tips Used in 3198 Irons

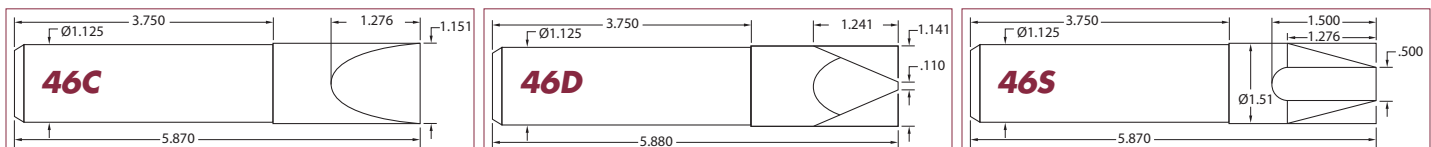

Soldering Irons

Paragon® Lead-Free Soldering Iron Tips (cont'd)

45 Series Tips Used in 3178 Irons

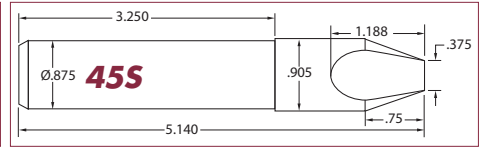
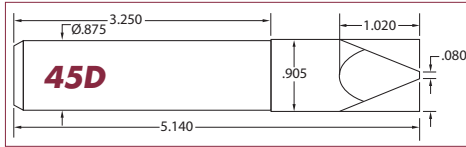
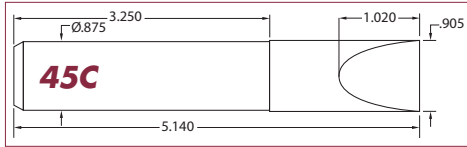

44 Series Tips Used in 3158 and 3158X Irons

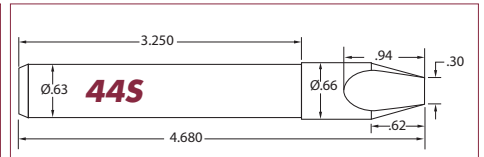
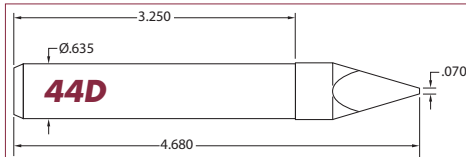
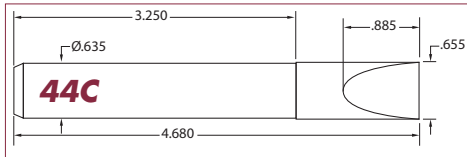

43 Series Tips Used in 3138 and 3138X Irons

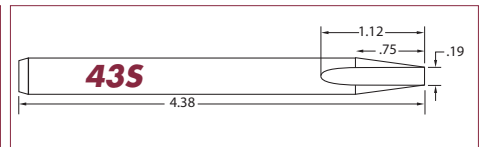
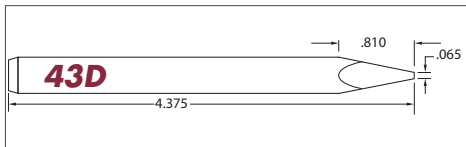
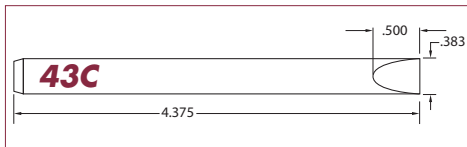

42 Series Tips Used in 3114 and 3125 Irons

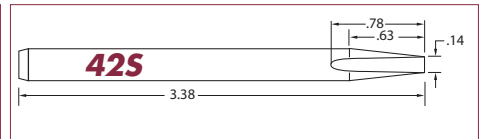
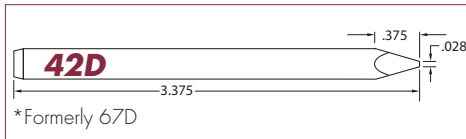
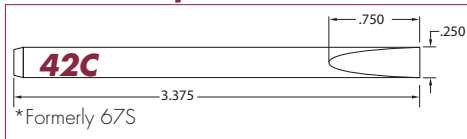

Voltage Controller



Model V3700

Voltage Controller

American Beauty® Soldering irons are full output irons designed and built to produce a tremendous amount of heat. Incorporating a voltage controller into your soldering process prolongs the life of your soldering irons' heating element and tip, reduces the thermal damage caused by excess heat build-up and saves energy and down-time by idling your iron at breaks.

This voltage controller is intended to use with our complete line of heavy-duty soldering irons, ranging from 60 to 550 Watts (Models 3114 to 3198). In addition, it can be used with our line of industrial solder pots (pages 12 & 13) to provide tighter control of temperature variation.

Weight – 1.0 lb. (.45kg)

Dimension (in): 3" x 4" x 5"

Dimension (cm): 9.5 x 10.0 x 13.3

Ergo Irons

Ergo Irons

An exacting laser cut followed by a precision brazing operation turns our Heavy-Duty Soldering irons into Ergo Irons. Ergo Irons have initial wattages ranging from 60 to 175 with corresponding maximum tip temperatures of 850°F to 1025°F.

Soldering all day can be a challenge. Workers have to deal with the heat, the fumes and the weight of the iron itself. If we can make it a little easier by reducing the tension on their hands and wrist, that's the least we can do.

The near 90 degree angle in the soldering iron casing allows the user to operate the iron from an ergonomically comfortable position—reducing tension in the hand and wrist. Irons perform to the same exacting standards of our straight soldering irons (see page 5) & are covered by the same, industry-best, 3-year warranty. Let your employees use the new Ergo Iron today!

Model Numbers:

3125E (available in 60 & 75 Watts)

3138E (available in 100, 130 & 150 Watts)

3138XE (available in 175 Watts)



Iron Maintenance Kits

Soldering Iron Maintenance Kits

Proper maintenance is the only way to ensure top performance and long life for your soldering iron. It does not take long for flux residue, contaminants and oxidation to build-up between the surface of a soldering iron's heating element and its soldering tip. This build-up has a negative effect on heat transfer as well as eventually leading to permanent tip seizure into the iron, rendering your tool unusable! Order our Total Soldering Iron Maintenance Kit (Model CS-ABKit) to service your complete soldering iron line, or if you only use one size iron, select the matching kit.

CS-ABKit: 3112 to 3198

CS-98Kit: 3198

CS-78Kit: 3178

CS-58Kit: 3158, 3158X

CS-38Kit: 3138, 3138X, 3138E, 3138XE

CS-14kit: 3112, 3114, 3125, 3125E



Soldering Irons

Production-Ready Pencil Style Irons



Model 3112

Model 3110

Model 3108

Features & Benefits

Ni-Chrome Compression Wound Heating Element

Proven to be the most reliable heating element for maintaining soldering temperature in production environments.

Paragon® Iron-Clad Lead-Free Tips

Consistently outperform and outlast ordinary tips.

Iron Uses Plug-Type Tips

Superior heat transfer. Easy maintenance.

Modular Construction

Easy replacement of any part.

Pencil Irons

The Little Guy that Really Packs a Punch

Designed in the same fashion as our Heavy-Duty Soldering Irons, these pencil-style irons are certainly not your average hobby iron. Referred to as production-ready, these irons repeatedly perform hard soldering applications. The combination of intense heat and unmatched durability yields a pencil iron that can proudly be called an American Beauty®.

A versatile tool in any maintenance and repair operation, specific applications of interest include being used to butt weld polyurethane belting (custom tip), soldering wiring in place on the connectors of neon light bulbs, and attaching large custom heat sinks to valuable PC boards.

MODEL	WATTAGE	MAXIMUM TIP TEMPERATURE	OVERALL LENGTH	STANDARD TIP STYLE	TIP SHANK DIAMETER	PRODUCT WEIGHT	REPLACEMENT ELEMENT
3112 (720)	60	1130°F (610°C)	7¾" (19.69cm)	Screwdriver	¼" (6.35mm)	4.5 oz. (127.6g)	9012
	50	1050°F (566°C)					
	40	950°F (510°C)					
The right soldering iron for soldering electrical and electronic connections such as lugs and posts. Enough heat for light to intermediate sheet metal and leaded glass. .							
3110 (618)	35	940°F (504°C)	6½" (16.51cm)	Screwdriver	3/16" (4.72mm)	3.0 oz. (85.1g)	9010
	30	890°F (477°C)					
	25	835°F (446°C)					
Perfect for soldering small to medium electronic and electrical connections.							
3108 (501)	30	970°F (521°C)	6½" (16.51cm)	Chisel	1/8" (3.18mm)	2.0 oz. (56.7g)	9014
	25	900°F (482°C)					
	20	805°F (429°C)					
Ideal for soldering miniature and small electronic connections, printed circuit board work and integrated circuits.							

***Shipping Weight Formula:**

For 1 - 10 irons, add ½ lbs. to the total product weight and round up to next whole number.
 For 11+ irons, add 1½ lbs. to the total product weight and round up to next whole number.

****Wattage Selection:** Some models are available in multiple wattages. Higher wattages equate with faster thermal recovery. While appropriate for overcoming heat sinks or in production environments, higher wattages may experience early element failure if heat is not drawn out of the iron frequently enough.

*****220-240 VAC versions and international cord sets are available upon request for Model 3112 only. Additional charges will apply.**

Paragon® Lead-Free Soldering Iron Tips

Starting with a pure copper core, our soldering iron tips undergo multiple processes to ensure the best performance and longest life. The following chart highlights our most popular styles of tips for each of the irons listed above. American Beauty® also carries many other shapes and style of tips, all of which can be found on our website at www.americanbeautytools.com/tips.

700 Series Tips Used in 3112 Irons

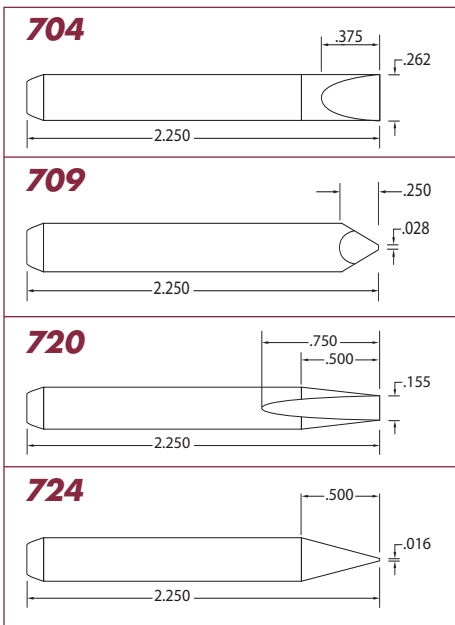

600 Series Tips Used in 3110 Irons

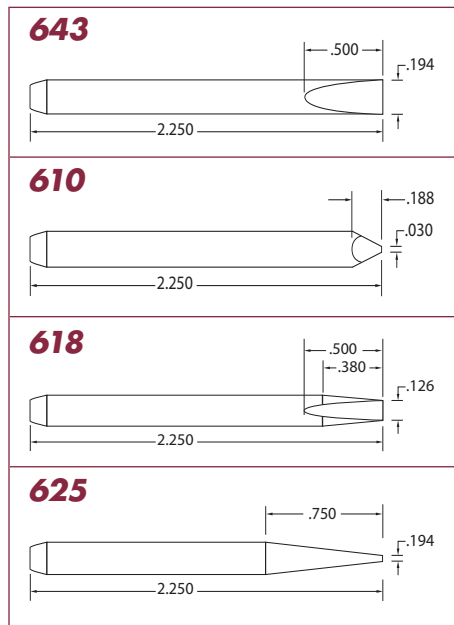

500 Series Tips Used in 3108 Irons

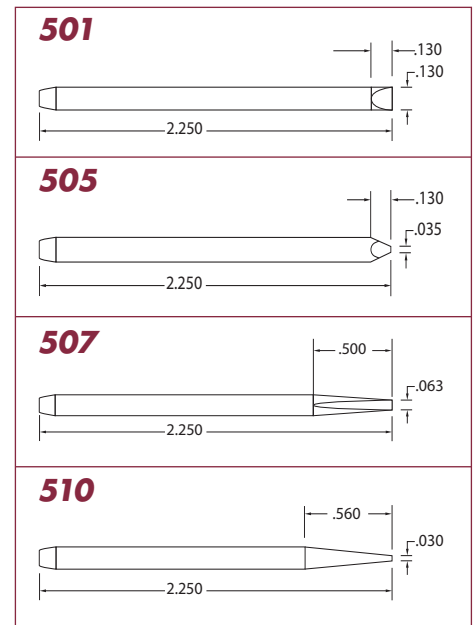

Soldering Irons

Industrial Grade Soldering Stations

These American Beauty® soldering stations offer the high thermal capacity of our production-ready pencil irons with amazing controllability. Industrial soldering stations are designed and built to perform under the most demanding production line conditions and withstand rugged usage in all maintenance and repair operations.

- Available in 20, 40 and 60 Watt Stations with corresponding 1/8", 3/16", and 1/4" diameter tips
- Standard Stations ship with Chisel, Diamond and Conical Style tips ensuring maximum suitability for most applications
- Dialing down during breaks and extended set-up times saves both energy and life of heating element
- Compact, bench top units come complete with detachable stands and dross collection sponges

Model V36L3



60 Watt Industrial Grade Soldering Station

Specifications:

- 1/4" Chisel, Diamond and Conical Style Soldering Tips
- Max Tip Temperature of 1,100°F
- Working Temperature Range of 225°F to 1,100°F

Weight: 1.0 lbs. (0.45kgs)

Standard Tips: 704, 709, 724

Diameter: 1/4"

Model V36M3



40 Watt Industrial Grade Soldering Station

Specifications:

- 3/16" Chisel, Diamond and Conical Style Soldering Tips
- Max Tip Temperature of 1,000°F
- Working Temperature Range of 200°F to 1,000°F

Weight: 0.9 lbs. (0.41kgs)

Standard Tips: 643, 610, 625

Diameter: 3/16"

20 Watt Industrial Grade Soldering Station

Specifications:

- 1/8" Diameter, Chisel, Diamond and Conical Style Soldering Tips
- Max Tip Temperature of 800°F
- Working Temperature Range of 175°F to 800°F

Weight: 0.8 lbs. (0.36kgs)

Standard Tips: 501, 505, 510

Diameter: 1/8"

Model V36S3



Desoldering Braid

Desoldering, Quick and Clean

Dri-Wick® Desoldering Braid simplifies the desoldering of printed circuit board components, posts, pots, flags, through-hole connections, pads and traces, as well as many non-PC board applications.

Features and Benefits:

- Pure Annealed Copper Braid
Cleanest, most efficient wick material. Attracts solder faster
- Water-White Rosin Flux Formula
Protects copper from oxidation and speeds wicking action without contamination
- Multiple Sizes
Available Widths: .035" (.9mm) to .130" (3.30mm)
Available Lengths: 5 foot and 50 foot spools



Model 485-8C

Dri-Wick® Desoldering Braid Disposable Dispenser

Features & Benefits:

- ESD Safe
- Disposable, Economical
- Available in Point of Sale Packaging
- 8 Feet of Desoldering Braid per Dispenser
- Thumb-wheel actuated

Width: .093" (2.37mm)



Model 484-1 thru -5



Features & Benefits

Grey Cast Iron Crucible

Chemically stable to keep solder pure.

Wide Lipped

Easy fixture mounting.

Superior Heat Control

Uniform solder temperature in crucible.

Internal Removable Dross Skimmer

Increases operator safety; maintains solder temperature.

Operational Warnings:

Operate only in well-ventilated workstations. Run Solder Pots on heat resistant surfaces. Solder Pots generate a great amount of heat and should never be left to operate unattended.

Built to Last!

Industry-leading Performance; Reliable Temperature Control

American Beauty® solder pots are renowned throughout the industry for superior performance and reliable control of solder temperature. Uses include tinning the ends of stranded wire leads, pre-tinning small electrical parts, re-tinning soldering iron tips and dip soldering small circuit boards. Internal dross is moved to lip where it cinders away. Dross skimmers are safer and more efficient than paddles, spoons and sticks that contaminate solder and lower temperature.

The optional dross skimmer assembly included with this product is made from stainless steel. Recent studies indicate that, over time, some Pb-Free solder alloys may have the capacity to dissolve stainless steel. Therefore if you choose to utilize the dross skimmer assembly in your RoHS compliant environment, we strongly recommend the periodic evaluation of this assembly for material loss and your solder alloy for possible contamination.

MODEL NUMBER	WATTAGE	ELEMENT NUMBER	CAPACITY	CRUCIBLE	OVERALL SIZE	WEIGHT
600	600	9300	2.5 lbs. (1.13kg)	I.D.: 3½" (8.89cm) Depth: 1½" (3.81cm) Center Tap: .3125" - 18	Top O.D.: 6.0" (15.24cm) Base Diameter.: 7.0" (17.78cm) Height: 5½" (13.97cm)	9.0 lbs. (4.08kg)
300	320	9301	1.0 lb. (.45kg)	I.D.: 2¼" (5.72cm) Depth: 1½" (3.81cm) Center Tap: ¼" - 20	Top O.D.: 4¾" (12.07cm) Base Diameter.: 5¾" (14.61cm) Height: 5.125" (13.02cm)	6.5 lbs. (2.95kg)

Common Applications: Typical uses include tinning the ends of stranded wire leads, pre-tinning small electrical parts, re-tinning soldering iron tips and dip soldering small printed circuit boards. Ideal solder pot for reliable control of solder temperature in harsh environments at an affordable price.

Temperature Range: 350°F - 850°F (176°C - 454°C)

Temperature Variation from Set Point: ± 50°F

Heating Time, Full pot to 400°F (204°C): 15 minutes

Heating Time, Full pot to 850°F (454°C): 25 minutes

Standard Voltage: 110-120 VAC, 50/60 hz
(220-240 VAC Available)

Can I use lead free solder in my American Beauty® Solder Pot?

The use of lead free solders is becoming more common every day. The primary concern regarding this trend is the effect that the higher tin content of many of the lead free solder alloys will have on current processes and tooling. The American Beauty® Solder Pot crucible is made of grey cast iron which does not readily dissolve into tin at temperatures below 800°F. Combine the fact that it is best standard practice to operate your solder pot no higher than 150°F above the liquid temperature of the solder being used with the fact that most lead free solder alloys liquefy below 500°F, and the result is that the American Beauty® line of solder pots is a great option for lead free solders.

Replacement Parts for Solder Pots

MODEL NUMBER	DESCRIPTION
302	Replacement Dross Skimmer Assembly for Model 300
602	Replacement Dross Skimmer Assembly for Model 600
8055	Replacement Thermostat for Model 300 and 600
9303	Replacement Cordset for Models 300 & 600
9300	Replacement Heating Cartridge (TWO heating cartridges are required to run the Model 600 solder pot.)
9301	Replacement Heating Cartridge (TWO heating cartridges are required to run the Model 300 solder pot.)
V3700	Voltage Control Unit (May be used with solder pot to achieve temperature variation of ± 5°.)

Introduction to Resistance Soldering

Definition

re•sist•ance sol•der•ing (ri-zis'təns sol-dər-ing) – a method of soldering where the heat to melt solder is instantaneously generated by passing an electrical current through a resistive material.



Core Requirements

Power Unit & Footswitch

The foundation of a resistance soldering system; produces and controls an ample supply of safe high amperage, low voltage current.

Handpiece

Completes an electrical circuit carrying the current from the source, through the pieces being soldered and back.

Electrode

Generates an instant and intense level of thermal output as current is forced through its highly resistive material.



Introduction to Resistance Soldering

Advantages

Smash Operational Bottlenecks

Concentrated heat reduces solder time many times over.

Improve Solder Joint Quality

Poor solder joints are often the result of insufficient heat throughout the joint, creating weak spots.

Eliminate Thermal Damage

Traditional soldering methods introduce too much heat into surrounding areas damaging critical components or desoldering of previously soldered joints.

Reduce Liability

Light-weight handpieces cool within seconds greatly reducing likelihood of repetitive strain injury and virtually eliminating the burn risk for the user.

Solder in Tight Spots

Versatile systems allow easy access to restricted areas.

Cut down on Energy Consumption

Instant heat means you're not paying to heat a soldering station all day long.

Save on Maintenance and Consumables

Electrodes last twice as long as soldering tips and don't require constant re-wetting.

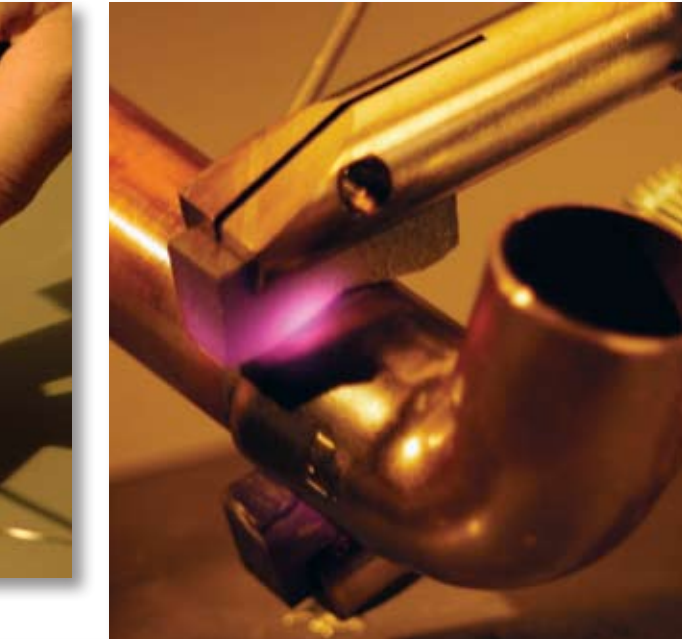

American Beauty®

When it comes to Resistance Soldering, no other company in the world combines the depth of knowledge with the breadth of product offerings as American Beauty®. We offer the widest selection of handpieces, electrodes and power units and back our equipment with the industry's best warranty. We work hand-in-hand with customers to help them realize the benefits of resistance soldering.

Resistance Soldering Systems - Tweezer Style

Model 105K5



ULTRA-HIGH CAPACITY TWEezer SYSTEM

Common Applications: Not only can you tackle applications using higher temperature solders, this system permits low temperature brazing, including compressor, refrigerant and other high pressure lines. Naturally the system can also handle antenna leads, semi-rigid coaxial cable, 1/4" connections, heavy-gauge wire, terminals, lugs.

Components: 105C1, 105227, 10519HW

Specifications:

- 1,800W (6.9VAC) Maximum Output Power Unit with 23 Unique Power Settings, Lighted Rocker, 15 AMP Circuit Protection & Heavy-duty steel case.
- Rugged, User-friendly Handpiece with seven foot (1.22m) 6 AWG high-strand DLO cable.
- Copper clad, stainless steel electrodes, 1/8" (1.98mm) Diameter, 3" Length. Easily customizable with approximate 5/8" opening upon shipping.
- Rugged, Industrial Footswitch with 6 foot (1.83m) cord.

Weight: 33.0 Lbs. (14.97 kg)

Replacement Electrode: Model 10594

Model 105L7



HIGH CAPACITY TWEezer SYSTEM

Common Applications: High temperature solders have become much more common in production environment as the lead-free solder movement takes hold. This system provides the extra power required to effectively tackle these applications, including antenna leads, semi-rigid coaxial cable, 1/4" connections, heavy-gauge wire, terminals, lugs.

Components: 105B2, 105127, 10519

Specifications:

- 1,100W (5.8VAC) Power Unit with 23 Unique Power Settings, Lighted Rocker, 10 AMP Circuit Protection & Heavy-duty steel case.
- Durable, User-friendly Handpiece with four foot (1.22m) 10 AWG High Strand DLO cord set.
- Copper clad, stainless steel electrodes, 1/8" (1.98mm) Diameter, 3" Length. Easily customizable with approximate 5/8" opening upon shipping.
- Rugged, industrial Footswitch with 6 foot (1.83m), three-wire cord and NEMA 5-15 P/R piggyback plug.

Weight: 25.0 Lbs. (11.34 kg)

Replacement Electrode: Model 10594

Model 10504



STANDARD CAPACITY TWEezer SYSTEM

Common Applications: Antenna leads and semi-rigid coaxial cable, connections up to 1/4" (6.5mm), heavy gauge wire, terminals, lugs, posts, bus bar terminations, cable and harness assemblies, heavy-duty soldering.

Components: 105A12, 105127, 10519

Specifications:

- 250W (2.8VAC) Power unit with Infinitely Variable Output control, Lighted Rocker, 3 AMP Circuit Protection & Heavy-duty aluminum case.
- Durable, User-friendly Handpiece with four foot (1.22m) 10 AWG High Strand DLO cord set
- Copper clad, stainless steel electrodes, 1/8" (1.98mm) Diameter, 3" Length. Easily customizable with approximate 5/8" opening upon shipping.
- Rugged, industrial Footswitch with 6 foot (1.83m), three-wire cord and NEMA 5-15 P/R piggyback plug.

Weight: 10.0 Lbs. (4.54 kg)

Replacement Electrodes: Model 10594

Resistance Soldering Systems - Tweezer Style

LIGHT CAPACITY TWEEZER SYSTEM

Common Applications: Wire processing, terminations, fiber optics, standard connections, electrical, electronics work, cable and harness assemblies.

Components: 105A12, 10541, 10519

Specifications:

- 250W (2.8VAC) Power unit with Infinitely Variable Output control, Lighted Rocker, 3 AMP Circuit Protection & Heavy-duty aluminum case.
- Durable, User-friendly Handpiece with four foot (1.22m) AWG 14-2 HPN cord set.
- Copper clad, stainless steel electrodes, 5/64" (1.98mm) Diameter, 1 1/2" Length. Easily customizable with approximate 1/4" opening upon shipping.
- Rugged, industrial Footswitch with 6 foot (1.83m), three-wire cord and NEMA 5-15 P/R piggyback plug.

Weight: 9.0 lbs. (4.08 kg)

Replacement Electrodes: 10542

Model 10502



ULTRA-LIGHT CAPACITY TWEEZER SYSTEM

Common Applications: Micro miniature setups, wire processing, terminations, small connections, PCB thru-hole.

Components: 105A3, 10541, 10519

Specifications:

- 100W (2.65VAC) Power unit with Infinitely Variable Output control, Pilot light, 1 AMP Circuit Protection & Heavy-duty aluminum case.
- Durable, User-friendly Handpiece with four foot (1.22m) AWG 14-2 HPN cord set.
- Copper clad, stainless steel electrodes, 5/64" (1.98mm) Diameter, 1" Length. Easily customizable with approximate 1/4" opening upon shipping.
- Rugged, Industrial Footswitch with 6 foot (1.83m), three-wire cord and NEMA 5-15 P/R piggyback plug.

Weight: 7.0 lbs. (3.175 kg)

Replacement Electrodes: 10542

Model 10501



MICRO CAPACITY TWEEZER SYSTEM

Common Applications: Micro-soldering applications in limited space, fine AWG wire processing, terminations, PCB thru-hole and very small connections.

Components: 105A3, 105133, 10519

Specifications:

- 100W (2.65VAC) Power unit with Infinitely Variable Output control, Pilot light, 1 AMP Circuit Protection & Heavy-duty aluminum case.
- Durable, User-friendly Handpiece with four foot (1.22m) AWG 18-2 HPN cord set.
- Ni-Chrome electrodes, .040" (1.02mm) Diameter, 1/2" Length. Easily customizable by forming or notching with approximate 3/8" opening upon shipping.
- Rugged, industrial Footswitch with 6 foot (1.83m), three-wire cord and NEMA 5-15 P/R piggyback plug.

Weight: 6.0 lbs. (2.72 kg)

Replacement Electrodes: 105134

Model 10599



Resistance Soldering Systems - Plier Style



Model 10505

ULTRA-HIGH CAPACITY PLIER SYSTEM

Common Applications: Thin Walled Copper Tubing up to 1 1/2". Heavy-Duty Applications where more critical control of intense heat is required. Large scale rebuilds. Operations involving significant heat sinks. Ideal for Tinel® Rings.

Components: 105C1, 10587, 10519HW

Specifications:

- 1,800W (6.9VAC) Maximum Output Power Unit with 23 Unique Power Settings, Lighted Rocker, 15 AMP Circuit Protection & Heavy-duty steel case.
- Durable, User-friendly Handpiece with ten foot (3.1m) 6 AWG high-strand DLO cable.
- Handpiece connects to power unit with 3/8" ring terminal & stud/wing nut system to accommodate higher output range.
- Concave Carbon Electrodes yield higher temperatures and allow for customization by grinding to fit application.
- Rugged, Industrial Footswitch with 6 foot (1.83m) cord.

Weight: 34.0 lbs. (15.42kg)

Replacement Electrodes: 10565



Model 105L5

HIGH CAPACITY PLIER SYSTEM

Common Applications: Thin Walled Copper Tubing up to 1/2". Large Military Connectors. Heavy-Duty Applications where more critical control of intense heat is required. Large scale rebuilds. Operations involving significant heat sinks. Ideal for Tinel® Rings up to 5/8".

Components: 105C1, 105358, 10519HW

Specifications:

- 1,800W (6.9VAC) Maximum Output Power Unit with 23 Unique Power Settings, Lighted Rocker, 15 AMP Circuit Protection & Heavy-duty steel case.
- Rugged, User-friendly Handpiece with four foot (1.22m) 6 AWG high-strand DLO cable.
- Two carbon block electrodes provide more intense heat than tweezer style Handpieces. Initial distance between electrodes is 1/2".
- Rugged, Industrial Footswitch with 6 foot (1.83m) cord.

Weight: 33 lbs. (14.97 kg)

Replacement Electrodes: 105159



Model 10507

STANDARD CAPACITY PLIER SYSTEM

Common Applications: A sizable step-up from the 10506. Copper Tubing, Semi-Rigid Coaxial Cable, Microwave Cable Connections and Terminal Attachments all up to 1/2". Larger Military Connectors. Motor Stators and Electrical Motor Rebuilders. Ideal for Tinel® Rings up to 5/8".

Components: 105B2, 105258, 10519

Specifications:

- 1,100W (5.8VAC) Power Unit with 23 Unique Power Settings, Lighted Rocker, 10 AMP Circuit Protection & Heavy-duty steel case.
- Durable, User-friendly Handpiece with four foot (1.22m) 10 AWG high-strand DLO cable.
- Two carbon block electrodes provide more intense heat than tweezer style Handpieces. Initial distance between electrodes is 1/2".
- Rugged, industrial Footswitch with 6 foot (1.83m), three-wire cord and NEMA 5-15 P/R piggyback plug.

Weight: 25.0 lbs. (11.34 kg)

Replacement Electrodes: 105159

Resistance Soldering Systems - Plier Style

LIGHT CAPACITY PLIER SYSTEM

Common Applications: Wire Harness Assemblies for larger AWGs. Copper Tubing, Semi-Rigid Coaxial Cable, Microwave Cable Connections and Terminal attachments all up to 3/16".

Components: 105A12, 105158, 10519

Specifications:

- 250W (2.8VAC) Power unit with Infinitely Variable Output control, Lighted Rocker, 3 AMP Circuit Protection & Heavy-duty aluminum case.
- Durable, User-friendly Handpiece with four foot (1.22m) AWG 14-2 HPN cord set. Initial distance between electrodes is 1/4".
- Two carbon block electrodes provide more uniform heat than tweezer style Handpiece Model 105127.
- Rugged, Industrial Footswitch with 6 foot (1.83m), three-wire cord and NEMA 5-15 P/R piggyback plug.

Weight: 10.0 lbs. (4.54 kg)

Replacement Electrodes: 105159

Model 10506



HEAVY DUTY PLUMBING SYSTEM

Common Applications: Our most powerful system for plumbing, HVAC, large cable work, battery terminals, motor leads and stator applications. Sweat solder thin-wall copper tubing up to 3" diameter. Brazes up to 5/8".

Components: 105D1, 10587, 10519HW

Specifications:

- Three tap selectable power outputs of 1000, 2000 and 3000W. (4.0 to 10.1VAC)
- Durable, user-friendly Handpiece with ten foot (3.1m) 6 AWG high-strand DLO cable.
- Handpiece connects to power unit with 3/8" ring terminal & stud/wing nut system to accommodate higher output range.
- Concave Carbon Electrodes yield higher temperatures and allow for customization by grinding to fit application.

Weight: 69.0 lbs. (31.3 kg)

Replacement Electrodes: 10565

Model 10577



MEDIUM DUTY PLUMBING SYSTEM

Common Applications: Strong enough for most plumbing, HVAC, large cable work, battery terminals, motor leads and stator applications. Sweat solder thin-wall copper tubing up to 1 1/2" diameter. Brazes up to 1/4".

Components: 105C2, 10587, 10519HW

Specifications:

- Three tap selectable power outputs of 500, 1300 and 1800W. (2.3 to 7.2VAC)
- Durable, User-friendly Handpiece with ten foot (3.1m) 6 AWG high-strand DLO cable.
- Handpiece connects to power unit with 3/8" ring terminal & stud/wing nut system to accommodate higher output range.
- Rugged, industrial Footswitch with 6 foot (1.83m), three-wire cord and NEMA 5-15 P/R piggyback plug.

Weight: 34.0 lbs. (15.42 kg)

Replacement Electrodes: 10565

Model 10557



Resistance Systems - Thermal Wirestripping



Model 10503

STANDARD CAPACITY WIRESTRIPPING SYSTEM

Common Applications: Thermal wirestripping from wires 14 AWG and finer.

Components: 105A3, 10517 & 10519

Specifications:

- 100W (2.65VAC) Power unit with Infinitely Variable Output control, Pilot light, 1 AMP Circuit Protection & Heavy-duty aluminum case.
- Durable, User-friendly Handpiece with four foot (1.22m) 14 AWG HPN cord set.
- Various types of elements available, including flat blades.
- Integrated stop mechanism provides for strip length ranging from 1/8" to 1 1/2" (3.18 to 38.10mm).
- Rugged, Industrial Footswitch with 6 foot (1.83m), three-wire cord and NEMA 5-15 P/R piggyback plug.

Weight: 7.0 lbs. (3.175 kg)

Replacement Elements: 10545



Model 10503P

PRODUCTION CAPACITY WIRESTRIPPING SYSTEM

Common Applications: In this system, an auto-switching cradle takes the place of a footswitch. Ideal for thermal wirestripping from wires 14AWG and finer in production style environments.

Components: 105A3T & 10517

Specifications:

- 100W (2.65VAC) Power unit with Infinitely Variable Output control, Pilot light, 1 AMP Circuit Protection & Heavy-duty aluminum case.
- Auto-switching, cradle-type On-Off switch increases productivity.
- Durable, User-friendly Handpiece with four foot (1.22m) AWG 14-2 HPN cord set.
- Various types of elements available, including flat blade.
- Integrated stop mechanism provides for strip length ranging from 1/8" to 1 1/2" (3.18 to 38.10mm).

Weight: 6.0 lbs. (2.72 kg)

Replacement Elements: 10545



Model 10503M

MICRO CAPACITY WIRESTRIPPING SYSTEM

Common Applications: Thermal Wirestripping from wires 24 AWG and finer.

Components: 105A3, 105131, 10519

Specifications:

- 100W (2.65VAC) Power unit with Infinitely Variable Output control, Pilot light, 1 AMP Circuit Protection & Heavy-duty aluminum case.
- Durable, User-friendly Handpiece with four foot (1.22m) AWG 18-2 HPN cord set.
- Elements constructed of .018" (.46mm) Ni-Chrome wire. Also available in short element style.
- Rugged, Industrial Footswitch with 6 foot (1.83m), three-wire cord and NEMA 5-15 P/R piggyback plug.

Weight: 5.5 lbs. (2.50 kg)

Replacement Elements: 105132

STANDARD CAPACITY PROBE SYSTEM

Common Applications: For general service in electrical equipment manufacture, rework or repair.

Components: 105B2, 10511, 10512, 10519

Specifications:

- 1,100W (5.8VAC) Power Unit with 23 Unique Power Settings, Lighted Rocker, 10 AMP Circuit Protection & Heavy-duty steel case.
- Durable, User-friendly handpiece with four foot (1.22m) 10 AWG High strand DLO Cable.
- Lead for current return with standard clamp and 10 AWG cabling.
- Copper clad, carbon electrodes, 1/4" (6.35mm) Diameter, 3" Length.
- Rugged, Industrial Footswitch with 6 foot (1.83m), three-wire cord and NEMA 5-15 P/R piggyback plug.

Weight: 24.0 lbs. (10.89 kg)

Replacement Elements: 10526



Model 10509

FIXED DUAL-PROBE SYSTEM

Common Applications: For soldering bus bars, lugs, starter and alternator leads, battery cables and similar electrical work.

Components: 105B2, 10513A, 10519

Specifications:

- 1,100W (5.8VAC) Power Unit with 23 Unique Power Settings, Lighted Rocker, 10 AMP Circuit Protection & Heavy-duty steel case.
- Panel attachment fixes directly to power unit, bring work to unit.
- Includes 1/2" diameter copper clad carbon electrodes.
- Rugged, Industrial Footswitch with 6 foot (1.83m), three-wire cord and NEMA 5-15 P/R piggyback plug.

Weight: 25.0 lbs. (11.34 kg)

Replacement Electrodes: 10534



Model 10535

ULTRA-LIGHT CAPACITY PROBE SYSTEM

Common Applications: Micro miniature setups, terminations, small connections, micro-soldering in hard to reach areas.

Components: 105A3, 10515, 10512A, 10519

Specifications:

- 100W (2.65VAC) Power unit with Infinitely Variable Output control, Pilot light, 1 AMP Circuit Protection & Heavy-duty aluminum case.
- Durable, User-friendly Handpiece with four foot (1.22m) 10 AWG High strand DLO Cable.
- Lead for current return with Alligator clip and 14 AWG cabling.
- Copper clad, Carbon electrode, 3/32" (2.36mm) Diameter, 3" Length.
- Rugged, Industrial Footswitch with 6 foot (1.83m), three-wire cord and NEMA 5-15 P/R piggyback plug.

Weight: 6.0 lbs. (2.72 kg)

Replacement Electrodes: 10530



Model 10508

Resistance Soldering - Replacement Products

Power Units: The Ultimate Backbone for every Soldering System

American Beauty® Resistant Soldering Power Units are recognized throughout the industry for their proven performance, reliability & safety.



Model 105A3

Max Output: 100 Watts
Power Settings: Infinite
Connections: Taper pins
Weight: 2.5 Lbs. (1.1 kg)
Dim. (in): 3" x 3-7/8" x 5"
Dim. (cm): 9.5 x 9.8 x 13.3
Color: Black Crackle Finish



Model 105B2

Max Output: 1,100 Watts
Power Settings: 23
Connections: Taper pins
Weight: 6 Lbs. (2.7 kg)
Dim. (in): 6" x 7" x 8"
Dim. (cm): 16.5 x 19.1 x 21.6
Color: Black Crackle Finish



Model 105A3T

Auto on/off switch
Max Output: 100 Watts
Power Settings: Infinite
Connections: Taper pins
Weight: 2.5 Lbs. (1.1 kg)
Dim. (in): 3" x 3-7/8" x 5"
Dim. (cm): 9.5 x 9.8 x 13.3
Color: Black Crackle Finish



Model 105C1

Max Output: 1,800 Watts
Power Settings: 23
Connections: Ring Terminals
Weight: 30 Lbs. (13.6 kg)
Dim. (in): 6" x 7" x 8"
Dim. (cm): 16.5 x 19.1 x 21.6
Color: Black Crackle Finish



Model 105A12

Max Output: 250 Watts
Power Settings: Infinite
Connections: Taper pins
Weight: 3 Lbs. (1.4 kg)
Dim. (in): 3" x 4" x 7-1/8"
Dim. (cm): 9.4 x 11.5 x 18.1
Color: Black Crackle Finish



Model 105C2

Max Output: 1,800 Watts
Power Settings: 3
Connections: Ring Terminals
Weight: 30 Lbs. (13.6 kg)
Dim. (in): 8" x 11" x 12"
Dim. (cm): 21 x 28 x 31
Color: Black Crackle Finish



Model 105D1

Max Output: 3,000 Watts
Power Settings: 3
Connections: Ring Terminals
Weight: 64 Lbs. (20 kg)
Dim. (in): 8" x 11" x 12"
Dim. (cm): 21 x 28 x 31
Color: Black Crackle Finish

Features & Benefits

Fail-Safe Devices

Ensure ultimate user safety.

Availability:

110/120V or 220/240V varieties.

Operated with a Variety of Handpieces

Allows user to customize resistance soldering to their particular needs.

3-Year Warranty:

Guarantees the product to be free from manufacturer defects and to work properly under normal operating conditions.

Reminder:

User should adhere to 50% duty cycle rule to ensure handpiece and power unit longevity. (i.e. Use for 10 second, rest for 10 seconds).

INTERNATIONAL CUSTOMERS

- Standard American Beauty® Resistance based systems operate on 110-120 VAC and are assembled with std 6 foot cordset with NEMA 5-15 North American 3 pronged plugs.
- All American Beauty® Resistance Systems are available in 220-240 VAC and/or with International Cordsets, upon special request.
- Unless otherwise requested, footswitches are hard-wired into all 220-240 versions.

Resistance Soldering - Replacement Products

Handpieces



Model 105227 - Industrial Tweezer Style Handpiece

Included in system(s): 105K5
Standard Replacement Electrodes: 10594
Length: 7" (17.8cm) w.4ft (1.2m) cordset
Electrodes can be customized/bent

Connection Type: Ring Terminals
Weight: 2.0 lbs. (.91kg)
Initial distance between electrodes: 5/8" (1.6cm)



Model 105127 - Standard Tweezer Style Handpiece

Included in system(s): 105L7, 10504
Standard Replacement Electrodes: 10594
Length: 7" (17.8cm) w.4ft (1.2m) cordset
Electrodes can be customized/bent

Connection Type: Taper Pins
Weight: 1.25 lbs. (.57kg)
Initial distance between electrodes: 5/8" (1.6cm)



Model 10541 - Light Tweezer Style Handpiece

Included in system(s): 10502, 10501
Standard Replacement Electrodes: 10542
Length: 5" (12.7cm) w.4ft (1.2m) cordset
Electrodes can be customized/bent

Connection Type: Taper Pins
Weight: 0.5 lbs. (.34kg)
Initial distance between electrodes: 1/4" (0.7cm)



Model 105133 - Micro Tweezer Style Handpiece

Included in system(s): 10599
Standard Replacement Electrodes: 105134
Length: 6" (15.2cm) w.4ft (1.2m) cordset
Electrodes can be customized/bent

Connection Type: Taper Pins
Weight: 0.5 lbs. (.23kg)
Initial distance between electrodes: 3/8" (1.0cm)



Model 10587 - Heavy-Duty Plier Style Handpiece

Included in system(s): 10505, 10577, 10557
Standard Replacement Electrodes: 10565
Length: 10" (25.4cm) w.10ft (3.0m) cordset
Electrodes can be customized/notched

Connection Type: Ring Terminals
Weight: 4.0 lbs. (1.8kg)
Initial distance between electrodes: 3" (7.6cm)



Model 105358 - Industrial Plier Style Handpiece

Included in system(s): 105L5
Standard Replacement Electrodes: 105159
Length: 7" (17.8cm) w.4ft (1.2m) cordset
Electrodes can be customized/notched

Connection Type: Ring Terminals
Weight: 2.0 lbs. (.91kg)
Initial distance between electrodes: 1/2" (1.3cm)



Model 105258 - Standard Plier Style Handpiece

Included in system(s): 10507
Standard Replacement Electrodes: 105159
Length: 7" (17.8cm) w.4ft (1.2m) cordset
Electrodes can be customized/notched

Connection Type: Taper Pins
Weight: 1.25 lbs. (.57kg)
Initial distance between electrodes: 1/2" (1.3cm)

Resistance Soldering - Replacement Products

Handpieces (cont'd)



Model 105158 - Light Plier Style Handpiece

Included in system(s): 10506
Standard Replacement Electrodes: 105159
Length: 5" (12.7cm) w.4ft (1.2m) cordset
Electrodes can be customized/notched

Connection Type: Taper Pins
Weight: 0.5 lbs. (.34kg)
Initial distance between electrodes: 1/4" (0.7cm)



Model 10536 - 1/2" Probe Style Handpiece

Rugged tool designed to handle extra heavy application requirements.
Suggested Power Unit: 105C1
Standard Replacement Electrodes: 10534
Length: 7" (17.8cm) w.4ft (1.2m) cordset
Electrodes can be customized/notched

Connection Type: Ring Terminals
Weight: 1.50 lbs. (.68kg)
Suggested Current Return Lead: 10537



Model 10511 - 1/4" Probe Style Handpiece

Included in system(s): 10509
Standard Replacement Electrodes: 10549
Length: 8" (20.3cm) w.4ft (1.2m) cordset
Electrodes can be customized/notched

Connection Type: Taper Pins
Weight: 0.5 lbs. (.23kg)
Suggested Current Return Lead: 10512



Model 10572 - 1/8" Carbon Probe Style Handpiece

Lightweight handpiece for micro-soldering in areas inaccessible to tweezers style handpieces.
Suggested Power Unit: 105A12
Standard Replacement Electrodes: 10524
Length: 6" (15.2cm) w.4ft (1.2m) cordset
Electrodes can be customized/notched

Connection Type: Taper Pins
Weight: 0.5 lbs. (.23kg)
Suggested Current Return Lead: 10512A



Model 10515 - 3/32" Probe Style Handpiece

Included in system(s): 10508
Standard Replacement Electrodes: 10530
Length: 6" (15.2cm) w.4ft (1.2m) cordset
Electrodes can be customized/notched

Connection Type: Taper Pins
Weight: 0.5 lbs. (.23kg)
Suggested Current Return Lead: 10512A



Model 10588 - 1/2" Dual Probe Style Handpiece

Based upon internal testing and customer response, the highest-quality and best performing large resistance soldering handpieces available on the market.
Suggested Power Unit: 105D1
Standard Replacement Electrodes: 10534
Length: 10" (25.4cm) w.10ft (3.0m) cordset
Electrodes can be customized/notched

Connection Type: Ring Terminals
Weight: 4.0 lbs. (1.8kg)
Initial distance between electrodes: 2.5" (6.4cm)



Model 10590 - 1/8" Fixed Dual Probe Style Handpiece

Ideal when repeatability is desired.
Suggested Power Unit: 105B2
Standard Replacement Electrodes: 10594
Length: 7.5" (19.1cm) w.4ft (1.2m) cordset
Electrodes can be customized/bent

Connection Type: Taper Pins
Weight: 1.0 lbs. (.45kg)
Initial distance between electrodes: 1/8" (0.3cm)

Resistance Soldering - Replacement Products

Handpieces (cont'd)



Model 10578 - 5/64" Fixed Dual Probe Style Handpiece

Ideal when absolute repeatability is desired.

Suggested Power Unit: 105A12

Standard Replacement Electrodes: 10582

Length: 6" (15.2cm) w.4ft (1.2m) cordset

Electrodes can be customized/bent

Connection Type: Taper Pins

Weight: 0.5 lbs. (.23kg)

Initial distance between electrodes: 1/8" (0.3cm)



Model 10517 - Regular Wirestripping Handpiece

Included in system(s): 10503P, 10503

Standard Replacement Elements: 10545

Length: 4" (10.2cm) w.4ft (1.2m) cordset

Varieties of elements available

Connection Type: Taper Pins

Weight: 0.75 lbs. (.34kg)

Ideal for stripping wires 14 AWG and finer



Model 105131 - Micro Wirestripping Handpiece

Included in system(s): 10503M

Standard Replacement Elements: 105132

Length: 5" (12.7cm) w.4ft (1.2m) cordset

Varieties of elements available

Connection Type: Taper Pins

Weight: 0.5 lbs. (.23kg)

Ideal for stripping wires 24 AWG and finer



Model 10597 - Large V-Notch Wirestripping Handpiece

Strips wires between 12 to 4 AWG, including coaxial cable to RG-8/U.

Suggested Power Unit: 105B2

Standard Replacement Elements: 10596

Length: 7.5" (19.1cm) w.4ft (1.2m) cordset

Varieties of elements available

Connection Type: Taper Pins

Weight: 1.0 lbs. (.45kg)

Ideal for stripping wires from 4 to 12 AWG



Model 10591 - Small V-Notch Wirestripping Handpiece

Single-loop element strips thermoplastics, including Teflon, from wires between 18 to 12 AWG.

Suggested Power Unit: 105A12

Standard Replacement Elements: 10593

Length: 5" (12.7cm) w.4ft (1.2m) cordset

Varieties of elements available

Connection Type: Taper Pins

Weight: 0.5 lbs. (.23kg)

Ideal for stripping wires from 12 to 18 AWG



Model 105142 - Solder Reflow Handpiece

Ideal for diverse reflow applications including: PC boards, general rework, repair, replacement of flatpacks, scarfing and parting of epoxied materials.

Suggested Power Unit: 105A12

Standard Replacement Elements: 105143

Length: 5" (12.7cm) w.4ft (1.2m) cordset

Varieties of elements available

Connection Type: Taper Pins

Weight: 0.5 lbs. (.23kg)

Ideal for diverse reflow applications



Model 105123 - Micro Reflow Handpiece

A tiny handpiece for soldering with solder pads - 1/64" to 1/32" (.40 to .80mm) or solder balls - .001" to .010" (.025 to .25mm) diameter. Element loop is .012" (.030mm) diameter. Ni-Chrome.

Suggested Power Unit: 105A3

Standard Replacement Elements: 10531

Length: 3" (7.6cm) w.4ft (1.2m) cordset

Shape element wire as desired





Connection Type: Taper Pins

Weight: 0.25 lbs. (.11kg)

Ideal for precise reflow applications up to .01" (.25mm)

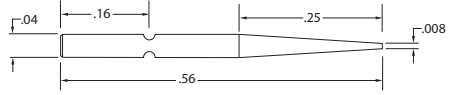
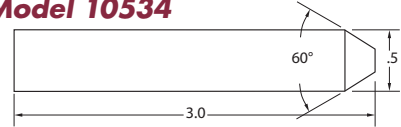
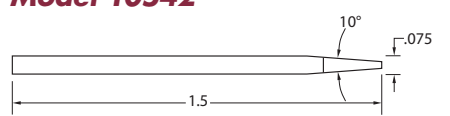
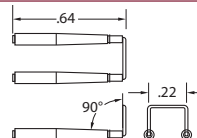
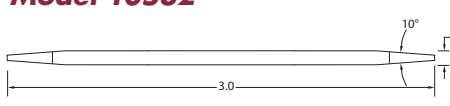
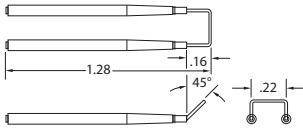
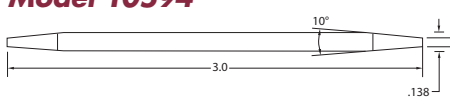
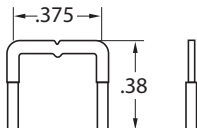
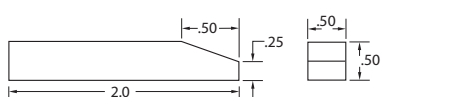
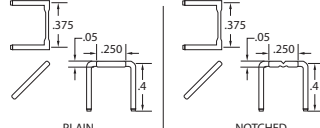
Resistance Soldering - Replacement Products

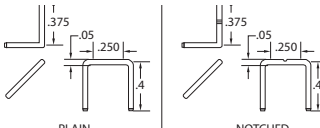
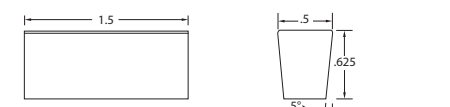
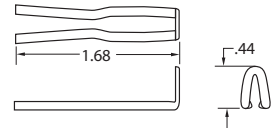
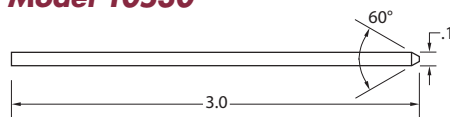
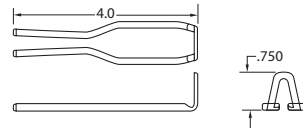
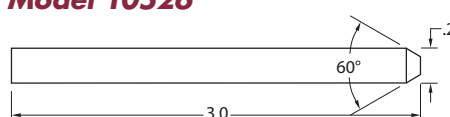
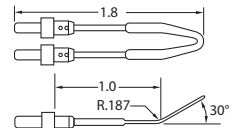
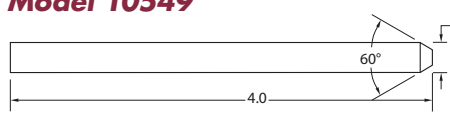
Replacement Electrodes & Elements

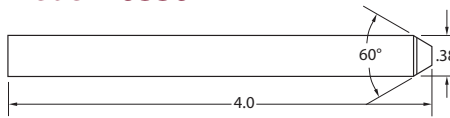
<p>Model 105134</p>  <ul style="list-style-type: none"> • Six Per Package • Ni-Chrome • Handpiece: 105133 	<p>Model 10534</p>  <ul style="list-style-type: none"> • Two Per Package • Copper Coated Carbon • Handpiece: 10536, 10588, 10513A
<p>Model 10542</p>  <ul style="list-style-type: none"> • Six Per Package • Copper Coated Stainless Steel • Handpiece: 10541 	<p>Model 105156</p>  <ul style="list-style-type: none"> • Two Per Package • Ni-Chrome • Handpiece: 105131
<p>Model 10582</p>  <ul style="list-style-type: none"> • Six Per Package • Copper Coated Stainless Steel • Handpiece: 10578 	<p>Model 105132</p>  <ul style="list-style-type: none"> • Two Per Package • Ni-Chrome • Handpiece: 105131
<p>Model 10594</p>  <ul style="list-style-type: none"> • Six Per Package • Copper Coated Stainless Steel • Handpiece: 105127 	<p>Model 10520</p>  <ul style="list-style-type: none"> • Two Per Package (both with center notch) • Ni-Chrome • Handpiece: 10517
<p>Model 105159</p>  <ul style="list-style-type: none"> • Two Per Package • Carbon • Handpiece: 105158, 105258 	<p>Model 10529</p>  <ul style="list-style-type: none"> • Two Per Package (one with center notch) • Ni-Chrome • Handpiece: 10517
<p>Model 10565</p>  <ul style="list-style-type: none"> • Two Per Package • Carbon • Handpiece: 10587 	<p>Model 10545</p>  <ul style="list-style-type: none"> • Two Per Package (one with center notch) • Ni-Chrome • Handpiece: 10517
<p>Model 10566</p>  <ul style="list-style-type: none"> • Six Per Package • Carbon • Handpiece: 10587 	<p>Model 10593</p>  <ul style="list-style-type: none"> • One Per Package • Ni-Chrome • Handpiece: 10591
<p>Model 10530</p>  <ul style="list-style-type: none"> • Six Per Package • Copper Coated Carbon • Handpiece: 10515 	<p>Model 10596</p>  <ul style="list-style-type: none"> • One Per Package • Ni-Chrome • Handpiece: 10597
<p>Model 10526</p>  <ul style="list-style-type: none"> • Six Per Package • Copper Coated Carbon • Handpiece: 10511 	<p>Model 105143</p>  <ul style="list-style-type: none"> • One Per Package • Ni-Chrome • Handpiece: 105142
<p>Model 10549</p>  <ul style="list-style-type: none"> • Six Per Package • Copper Coated Carbon • Handpiece: 10511 	<p>Model 10531</p>  <ul style="list-style-type: none"> • 10 foot Nickel-Chrome wire, wound on one plastic bobbin • Handpiece: 105123
<p>Model 10550</p>  <ul style="list-style-type: none"> • Six Per Package • Copper Coated Carbon 	<p>This is simply a list of our most popular electrodes and elements. Please visit our website (www.americanbeautytools.com) for a complete list.</p>

Resistance Soldering - Replacement Products

Resistance Soldering Accessories



Model 10519 & 10519HW

FOOTSWITCH & HIGH CAPACITY FOOTSWITCH

Eliminates sparking on contact and removal of electrodes from work. Provides more accurate timing of soldering operations. Recommended in most applications. A rugged, industrial switch with six foot (1.83m) three-wire cord and NEMA 5-15 P/R piggyback plug.

Standard footswitch: $\leq 1,100$ Watts

High Capacity: $>1,100$ Watts

Weight: 1.0 Lbs. (0.45 kg)



Model 105PTM

Combine the intense power of resistance soldering with precision cycle time repeatability!

Designed for use with Power Units set at or below 1,200 Watts. Digital LCD Timer Module w/multiple functionality Run light, Lighted Rocker Switch, 10 AMP Circuit Protection & Heavy-duty aluminum case. Available in 110 or 220V. Rugged, Industrial Footswitch with 6 foot (1.83m) w/3.5mm micro-jack plug for low voltage activation. Three conductor, Detachable AC Cord set.

Weight: 1.5 Lbs. (0.68 kg)

Accessories



GROUNDING VISE - 105V12

- For use with single electrode resistance soldering or tweezer handpieces with Model 105Y10 adapter
- Compatible with power units up to and including Model 105C2 at 1,800W and all single electrode handpieces



Model 10513A

- Attaches to 105B2
- Uses Electrodes: 10534



ADAPTER - 105Y10

Connects both jaws of soldering tweezers to one terminal of power unit resulting in slightly more even heating. Must use with return lead.

Leads for Return Current



Required for establishing current return when using single electrode handpieces or Model 105Y10 Adapter. Three models are available.

Model 10512A -

- Alligator Clamp
- 14 AWG Cable
- Connection: Taper pins



Model 10512-

- Standard Clamp
- 10 AWG Cable
- Connection: Taper pins



Model 10537

- Heavy-Duty "C" Clamp
- 6 AWG Cable
- Connection: Ring Terminals

In-House Test & Evaluation Service

Is your soldering job the bottle-neck of your assembly operation? Did the only person in your company with soldering expertise retire two years ago? Does your manager require proof of a new tool's effectiveness but won't allocate funds for testing? Not to worry. American Beauty® proudly offers our free in-house test and evaluation service.

Our trained technicians will work closely with you to evaluate the current soldering process, identify root causes of problem areas and determine American Beauty®'s capacity to deliver the solution. We will then video tape our technician performing your soldering job in our testing lab and return any samples for evaluation. Call us today for more information at 800.550.2510.



Repair & Refurbishment Service

American Beauty® Soldering Tools are designed to withstand the rigors of production-line usage in the most difficult industrial environments. All tools are covered for workmanship and against defect by our industry best three year warranty policy.

We have expanded our internal repair department and re-assigned our most experienced technicians to work on repairs. We implemented customized software to ensure accurate processing of all returned products. Combining our tradition of excellence and service versatility, American Beauty® provides world-class repair and refurbishment service.

Quality – All work is performed by our trained and certified technicians and covered under our Industry Leading Three Year Warranty policy.

Speed – Once in house, 90% of repairs are turned around inside of 48 hours.

Savings – The combined cost of parts, labor and return shipping is often less than half the cost of a new tool.



American Beauty® Products

1177 W. Maple Road • Clawson, MI 48017-1059 U.S.A.

Toll Free: 1.800.550.2510 • Phone: 1.248.280.2810 • Fax: 1.248.280.2878

www.americanbeautytools.com